



## MINATO SEIKI IRON WORKS CO.,LTD.

3-20-7, Karasaki-Naka, Takatsuki City, Osaka, 569-0832, Japan

Phone: +81-72-677-5743 Facsimile: +81-72-678-5237

URL: <http://www.taiyo-lashing.com>



CONTAINER SECURING SYSTEM



# Container Lashing System

Since the year 1985, TAIYO developed Semi-Automatic Twistlock Model : NA-7 as world's first which was revolutionary products in the container lashing fields. In 1990, approximately a half of technical patents concerned with container lashing devices belongs to TAIYO which means we are the leading company of container lashing devices in the world.

In 2005, we developed the Fully Automatic Twistlock Model : FA-8 which contribute a lot of profit to the customers - safety, quick and low cost cargo handling etc. Our technology contribute to the world both safety and cost reduction.



## Fully Automatic Twistlock

TAIYO's latest model Fully Automatic Twistlock Model FA-8 is no need to "Lock"/"Unlock" work which contribute to the safety and laborsaving during container cargo handling.  
\*Comply with OSHA rules



## Semi-Automatic Twistlock NA-3J (Dual Function)

Semi-Automatic Twistlock Model : NA-3J is the best seller in the world which have the function "Automatically Lock" and "Manually Unlock".

\*Comply with OSHA rules



## Twist Stacker

Twist Stacker Model : M-1ST is the "hanging type" which is used in the cargo hold.

\*Comply with OSHA rules

\*OSHA rule : OSHA is a short word of "Occupational Safety & Health Administration" which regulate the labor's safety and health. TAIYO's products fully comply with OSHA rules.

## Container Lashing System (Loose & Fixed Gears)

### Container Vessel



### Ex : Lashing Pattern On Deck

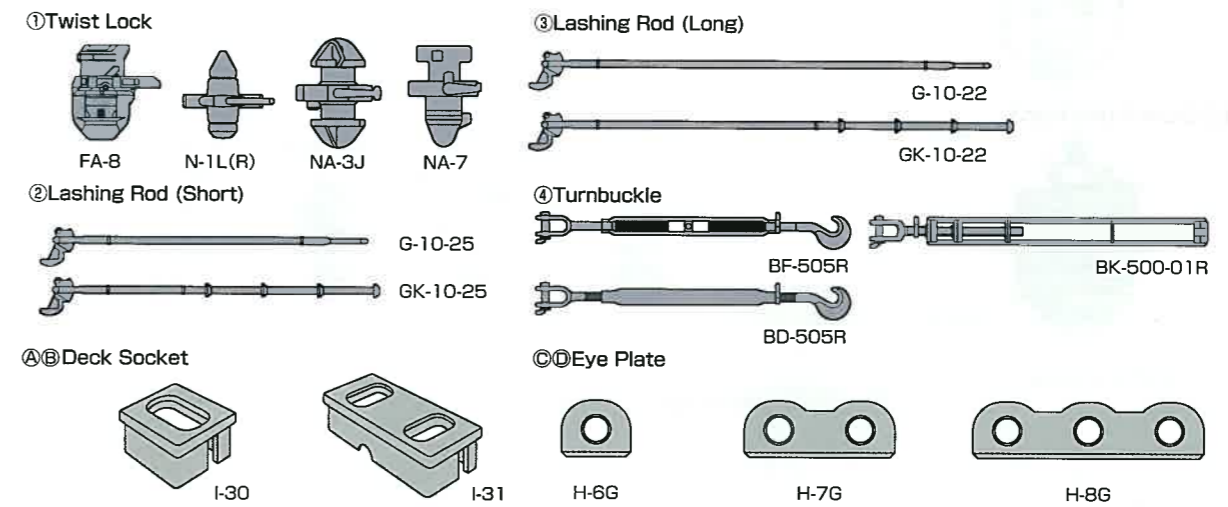
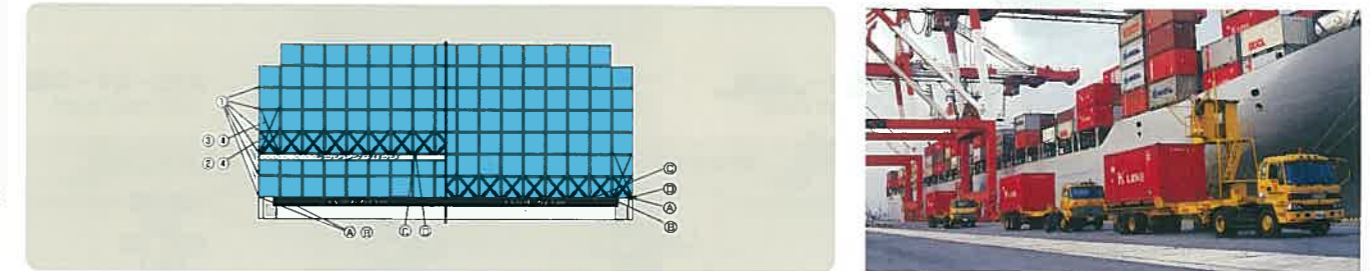

### Ex : Lashing Pattern In Hold

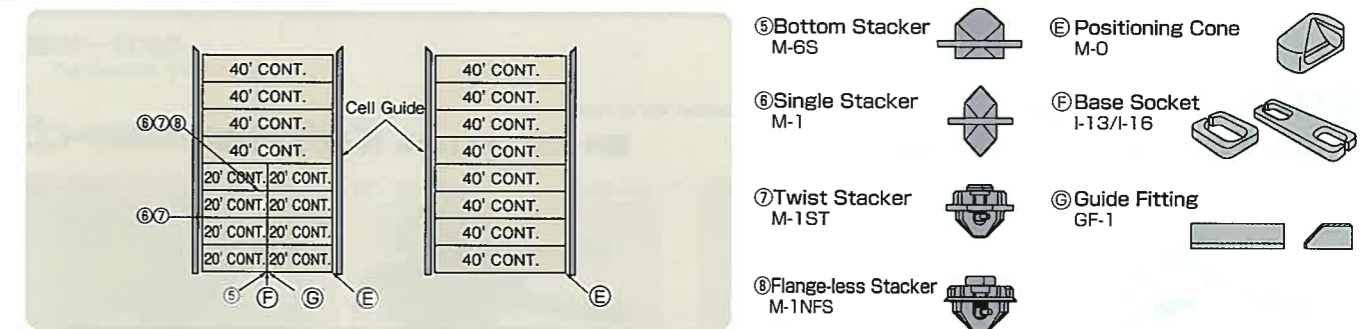

## ISO Ocean Freight Container Box Standard (Outlook dimension)

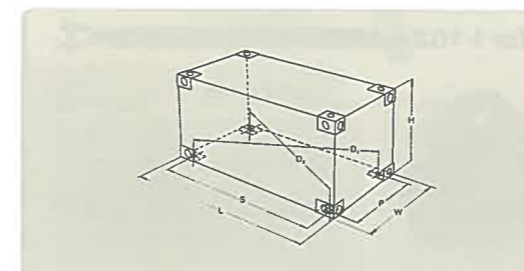

TABLE OF EXTERNAL DIMENSIONS OF ISO FREIGHT CONTAINER (ISO 668:1995, ISO 668:1995/Amd.2:2005)

型式	HEIGHT (H)		WIDTH (W)		LENGTH (L)		S	P	D1 - D2 MAX.
	DIMENSIONS	TOLERANCE	DIMENSIONS	TOLERANCE	DIMENSIONS	TOLERANCE			
1AAA	2896 (9'6")				12192	0	11985	2259	19
1AA	2591 (8'6")				40'	-10			
1A	2438 (8')	0	2438 (8')	0					
1CC	2591 (8'6")	-5		-5	6058 (20')	0	5853		13
1C	2438 (8')					-6			
1EEE	2896 (9'6")				13716 (45')	0	13509		19
1EE	2591 (8'6")					-10			

## Twistlock TAIYO

### Fully Automatic Twistlock

Unit=mm

■FA-8



NTW:6.5kg

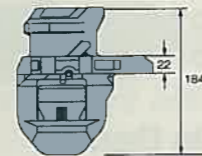

### Semi Automatic Twistlock

Unit=mm

■NA-7(Single Function)



NTW:6.9kg

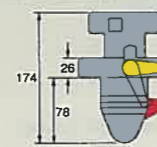

Lock Position

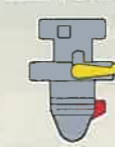

Open Position



■NA-3J(Dual Function)



NTW:7.2kg

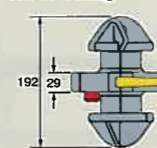

Upper Cone Open Position



Lock Position

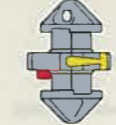

Lower Cone Open Position



■EM-1(Dual Function)



NTW:7.2kg

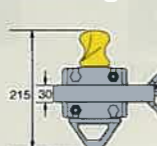

Upper Cone Open Position



Lock Position



Lower Cone Open Position



### Manual Twistlock

Please confirm the locking position "left" or "right"

■N-1L(Left Lock Type, 2 notch)



NTW:5.6kg

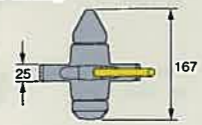

■N-2L(Left Lock Type, 3 notch)



NTW:6.5kg

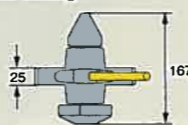

### Sliding Twistlock

Please confirm the locking position "left" or "right"

■N-3TL(Left Lock Type, for I-22/I-23)



NTW:9.0kg

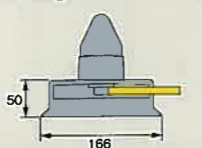

■NA-9L(for I-102/I-103)



NTW:6.0kg

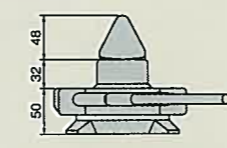

## Lashing Rod & Turnbuckle TAIYO

### Lashing Rod

Please confirm "length" and "knob pitch" when you order the rods.

■G-10-25 Short Rod

Unit=mm



B.L:50MT L=2100mm  
NWT:10.4kg



■G-10-22 Long Rod

Unit=mm



B.L:36MT L=4600mm  
NWT:16.3kg

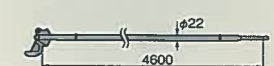

■G-10-25A Equal-Lash Rod

Unit=mm



B.L:50MT L=2150mm  
NWT:12.2kg

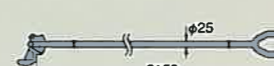

■GK-10-25 Short Rod (Knob Type)

Unit=mm



B.L:50MT NWT:13.2kg

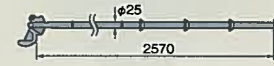

■GK-10-22 Long Rod (Knob Type)

Unit=mm



B.L:36MT NWT:18.3kg



■G-8-50 Extension Rod

Unit=mm



B.L:50MT NWT:3.0kg



■G-8-2R-50 Extension Rod

Unit=mm



B.L:50MT NWT:6.4kg



### Turnbuckle

Confirm required stroke

■BF-505R Turnbuckle (Frame Type)



BF-505 Unit=mm

B.L:50MT  
Stroke min880~max1320  
NWT:13.2kg



BF-505R Unit=mm

B.L:50MT  
Stroke min965~max1500  
NWT:14.9kg

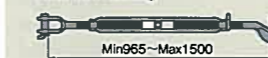

■BD-505R Turnbuckle (Pipe Type)



BD-505R Unit=mm

B.L:50MT  
Stroke min965~max1500  
NWT:14.0kg



■BF-505E Equal-Lash Turnbuckle



BF-505E Unit=mm

B.L:65MT  
Stroke min1030~max1670  
NWT:20.0kg

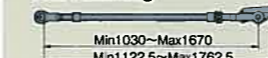

BF-505ELL Unit=mm

B.L:65MT  
Stroke min1160~max1930  
NWT:22.6kg

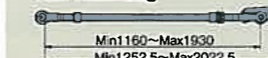

■BK-500-01R Turnbuckle (Knob Type)



BK-500-01R Unit=mm

B.L:50MT  
Stroke min1146~max1481  
NWT:14.9kg

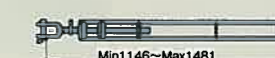

## Stacker, Bridge Fitting and Others TAIYO

### Twist Stacker

Unit=mm

#### M-1ST

Twist Stacker



NWT:2.7kg



#### M-1NFS

Flange less Stacker



NWT:2.1kg

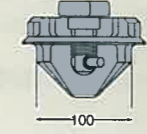

### Vertical Stacker

Unit=mm

#### M-1

Single Stacker



NWT:2.8kg

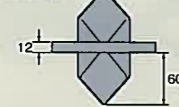

#### M-2

Double Stacker



NWT:9.2kg

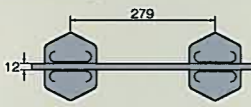

#### M-6S(for I-31/I-16)

Bottom Stacker



NWT:2.6kg

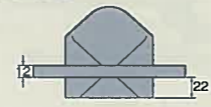

#### M-3

Double Stacker



NWT:8.3kg

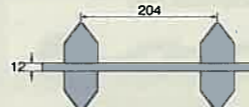

### Bridge Fitting

Unit=mm

#### L-3/LH-3

Bridge Fitting



NWT :4.5kg/1.3kg



#### L-3L/LH-3

Bridge Fitting



NWT :4.9kg/1.3kg



### Release Bar (for twistlock operation)

Unit=mm

#### Aluminum



Head Piece

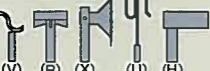

#### Glass Fiber



Head Piece

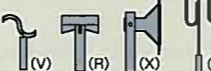

- Aluminum release bar is order made and we can provide required length.
- Over 5m long will be "joint type"(Ex : 10m=5m+5m)
- Please instruct head pieces when you order.
- Reference : Applicable twistlocks are : (V) for NA-7 (R) for NA-3J (U) for EM-1 and (H) for N-1/N-2

- Except model RL-V-20(2m), RL-V-50-1(5m) and RL-V-29(Joint 2.9m) are order made.
- Total length shall be adjusted by using joint 2.9m on 2m or 5m.(i.e.2m or 5m +2.9m pitch)
- Please instruct head pieces when you order.
- Except (V) type head pieces will be order made.
- Reference : Applicable twistlocks are : (V) for NA-7 (R) for NA-3J (U) for EM-1 and (H) for N-1/N-2

### Flat Rack Container&Stowage Bin

#### FR-20 20ft flat rack container & stowage bins(8pcs)

NWT :2400kg



NWT :200kg/1個

#### FR-40 40ft flat rack container & stowage bins(14pcs)

NWT :5100kg



NWT :200kg/1個

## Fixed Gear TAIYO

### Deck Socket, Sliding Base and Eye Plate

Unit=mm

#### I-30

Deck Socket (ISO Single)



NWT:8.4kg

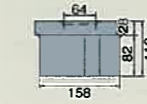

#### I-31

Deck Socket(ISO Double)



NWT:17.5kg



#### I-50C

Cast Steel Deck Socket (ISO Single)



NWT:6.8kg



#### I-51C

Cast Steel Deck Socket (ISO Double)



NWT:13.9kg

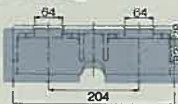

#### I-102(Raised Type)

Disk Socket



NWT:2.5kg



#### I-22(for N-3TL)

Sliding Base(Single)



NWT:3.0kg



#### I-103(Sunken Type)

Disk Socket



NWT:3.3kg



#### I-23(for N-3TL)

Sliding Base(Double)



NWT:6.0kg



#### I-100A(for I-102/I-103)

Disk Socket Cover



NWT:0.2kg



#### H-6G

Eye Plate(Single)



NWT:1.5kg

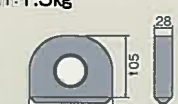

#### H-7G

Eye Plate (double)



NWT:4.0kg

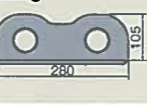

#### H-8G

Eye Plate (TriPLICATE)



NWT:6.3kg

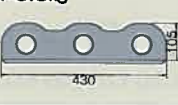

#### I-13

Base Socket(Single)



NWT:2.4kg



#### I-16

Base Socket(Double)



NWT:9.0kg



#### M-6S(I-13/I-16用)

Bottom Stacker



NWT:2.6kg



#### M-0

Positioning Cone



NWT:1.3kg



# Vehicle Lashing Devices TAIYO

## Belt Lashing (Lockner)

### ■K-205

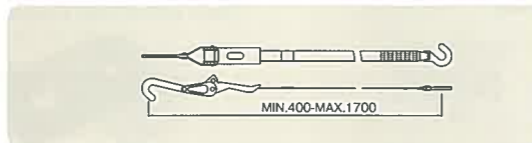

Finish	Dacrotized
NWT	0.72kg
S.W.L	0.5MT ( 4.9 kN) (Tensile Strength)
B.L	2.0MT ( 19.6 kN)

### ■T-411/412/413

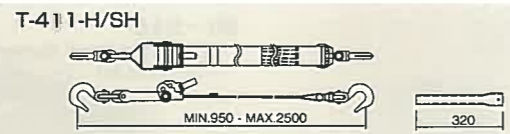

Finish	Dacrotized
NWT	5.5kg
S.W.L	2.5MT ( 24.6 kN) (Tensile Strength)
B.L	10.0MT ( 98 kN)

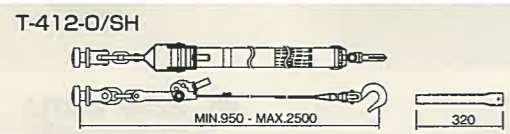

Finish	Dacrotized
NWT	5.8kg
S.W.L	2.5MT ( 24.6 kN) (Tensile Strength)
B.L	10.0MT ( 98 kN)

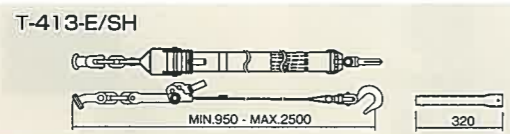

Finish	Dacrotized
NWT	5.8kg
S.W.L	2.5MT ( 24.6 kN) (Tensile Strength)
B.L	10.0MT ( 98 kN)

### ■K-110-E/SH

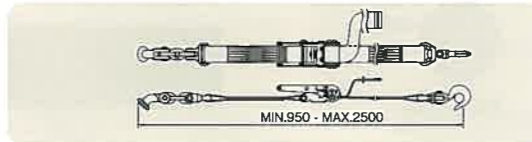

Finish for Buckle	Electroplating
Finish for main portion	Dacrotized
NWT	8.0kg (Tensile Strength)
S.W.L	2.5MT ( 24.6 kN)
B.L	10.0MT ( 98 kN)

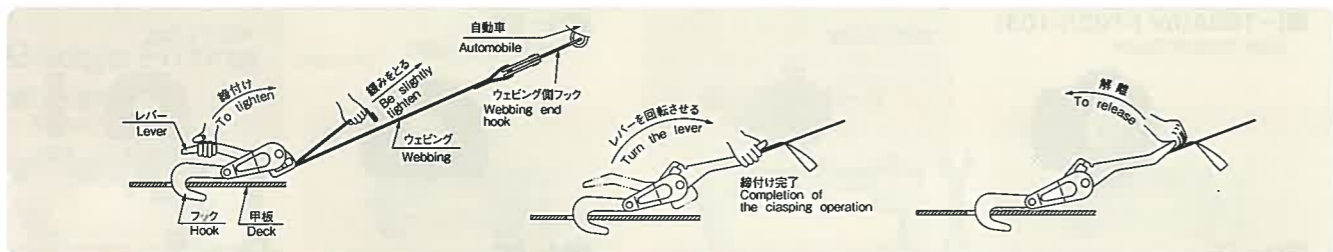

## Wire Rope type Lashing (Car Stopper)

### ■T401/402/403

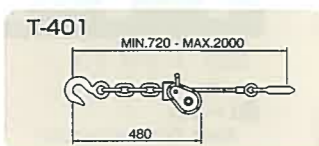

Finish	Painted
NWT	10.3kg
S.W.L	2.25MT (22.1 kN) (Tensile Strength)
B.L	9.0MT (88.3 kN)

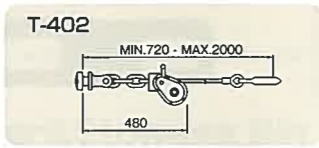

Finish	Painted
NWT	10.3kg
S.W.L	2.25MT (22.1 kN) (Tensile Strength)
B.L	9.0MT (88.3 kN)

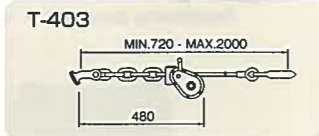

Finish	Painted
NWT	10.3kg
S.W.L	2.25MT (22.1 kN) (Tensile Strength)
B.L	9.0MT (88.3 kN)

### Ratchet Handle 471-A

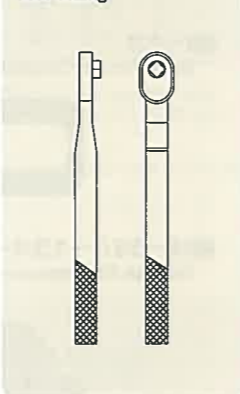

●End device shall be decided by fixed gear on vessel.

## Chain Lashing (Speed Turnbuckle)



### ■T-501

NWT:16.8kg(including sub chain)



### ■T-502

NWT:16.8kg(including sub chain)



### ■T-504

NWT:16.8kg(including sub chain)



KEY PLAN  
T-501/502/504(T-503)



### ■Sub ChainT-503

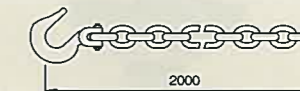

### ■Crank Handle571-B

NWT:0.7kg

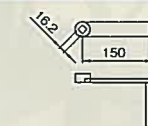

Finish	Painted
NWT:	16.8kg (including sub chain)
S.W.L	4.0MT ( 39.3 kN) (Tensile Strength)
B.L	6.0MT (156.9 kN)

●End device shall be decided by fixed gear on vessel.

## Chain Lashing

### ■BF-202



### ■BF-205

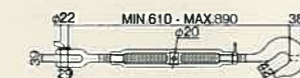

### ■BF-200V



KEY PLAN



KEY PLAN

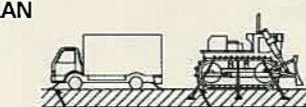

### ■Handle for Turnbuckle TBH-1

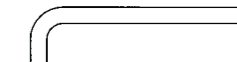

### ■Lashing ChainF-206

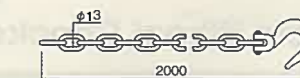

Finish	Galvanized Plating
NWT:	7.0kg
B.L	16.0MT(Tensile Strength)

## Chain Tensionner

### ■C-2



NWT:4.7kg

Tensionner KEY PLAN

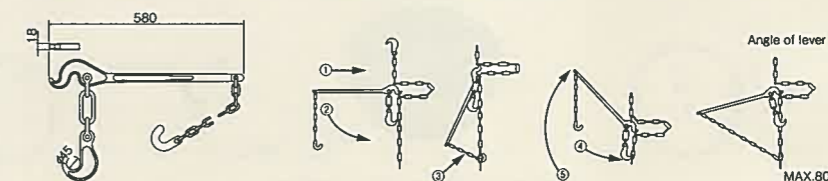

## Vehicle Lashing Devices **TAIYO**

### Sub Landing Gear



■PK-3B

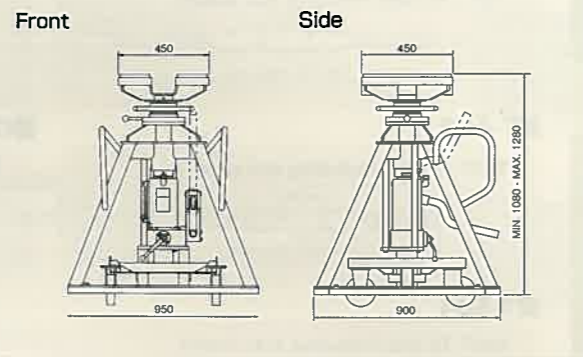

NWT:	195kg
Lifting Load	30.0MT (294kN)
Breaking Load	60.0MT (588kN)

■PNS-3A(PNS-3B)

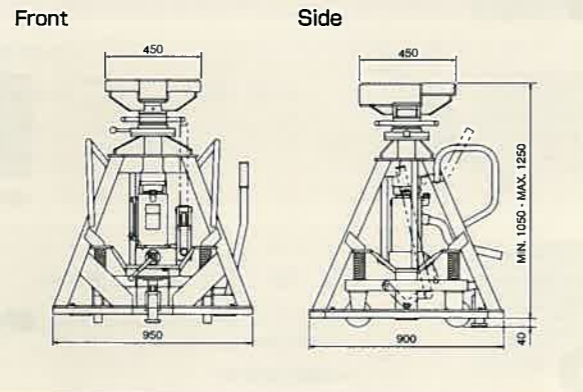

NWT:	約220kg
Lifting Load	30.0MT (294kN)
Breaking Load	60.0MT (588kN)

### Vehicle Wheel Chocks



■P-6-S  
(rubber made for small vehicle)

NWT:1.6kg

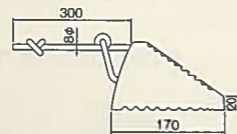

■P-6-L  
(rubber made for big vehicle)

NWT:5.0kg

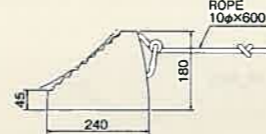

■P-5-S  
(wooden made for small vehicle)

NWT:4.0kg

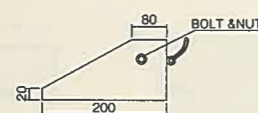

■P-5-L  
(wooden made for big vehicle)

NWT:7.0kg

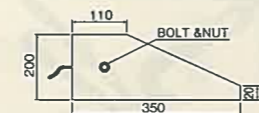

## Fixed Gear **TAIYO**

### Clover Leaf Plate

■J-5-250(Raised Type)



NWT:5.3kg

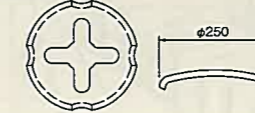

■J-4-250(Flush Type)

NWT:10.3kg

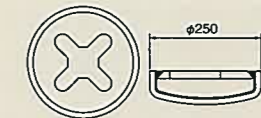

■J-4-300(Flush Type)



NWT:8.0kg

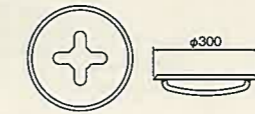

### D-Ring

■H-1-13



B.L	8.0MT (Vertical Tensile Strength)
NWT:	0.4kg

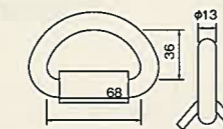

■H-1-16



B.L	20.0MT (Vertical Tensile Strength)
NWT:	1.3kg

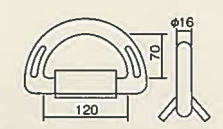

■H-1-22



B.L	50.0MT (Vertical Tensile Strength)
NWT:	4.3kg



■H-2-16(Sunken Type)



### Clinkle Bar (Order made)

■HC-2-13



B.L	6.0MT
NWT:	0.5kg



■HC-2-19



B.L	18.0MT
NWT:	1.2kg



### Lashing Socket

■JX-250



B.L	20.0MT (196kN)
NWT:	2.2kg

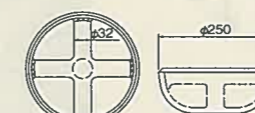

■JX-114R



B.L	5.0MT (49kN)
NWT:	2.2kg

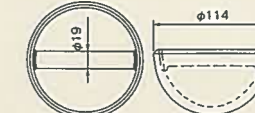

## Log Lashing System

### Ordinary lashing wire arrangement (reference only)

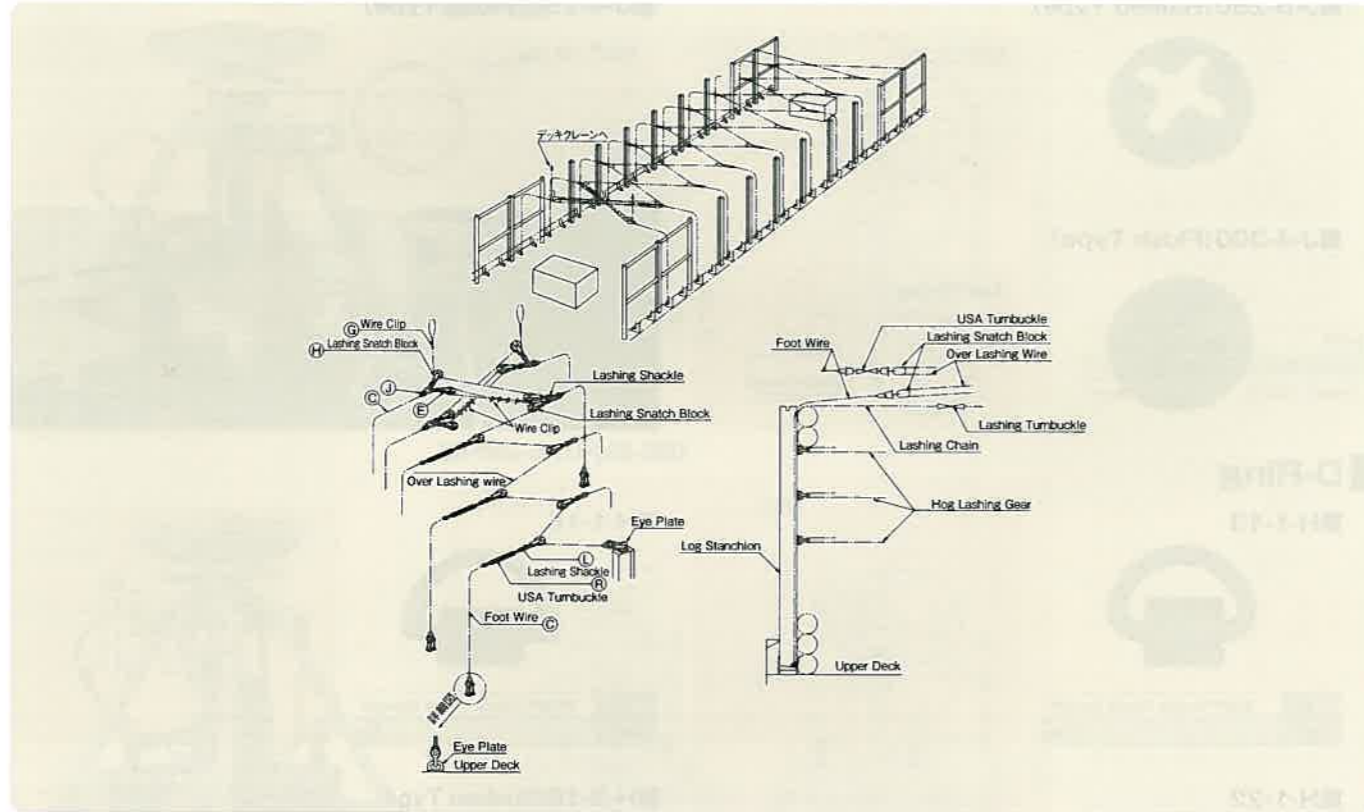

### Lashing Snatch Block

■TS-150

NTW: 14.7kg

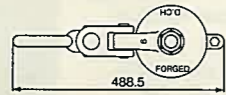

### Lashing Turnbuckle (for chain use)

■BF-160H

NTW: 12.5kg

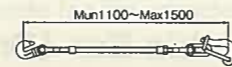

### Ordinary lashing chain arrangement (reference only)

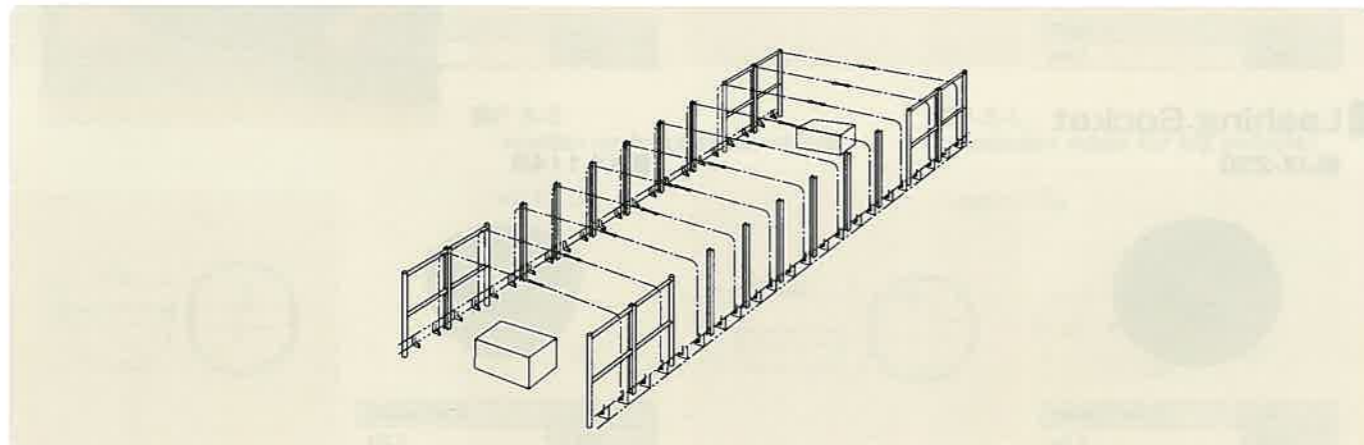

## Lifting Device TAIYO

### Container Lifting Spreader

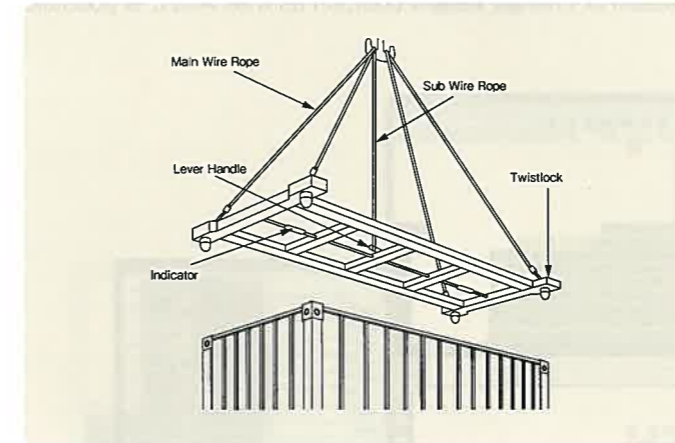

Both Semi Automatic operation type and Manual operation type are available

■20 feet

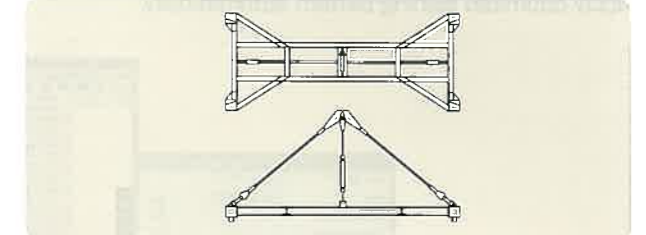

■40 feet

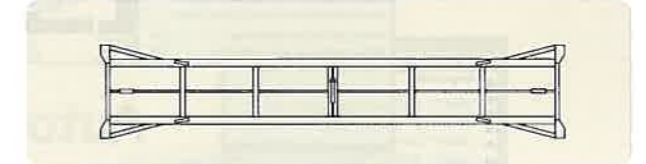

### Over Height Attachment

■20 feet

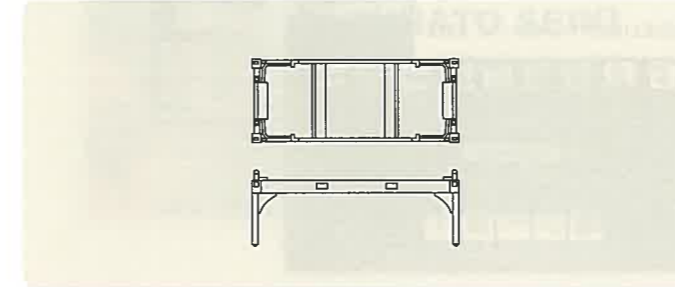

■40 feet

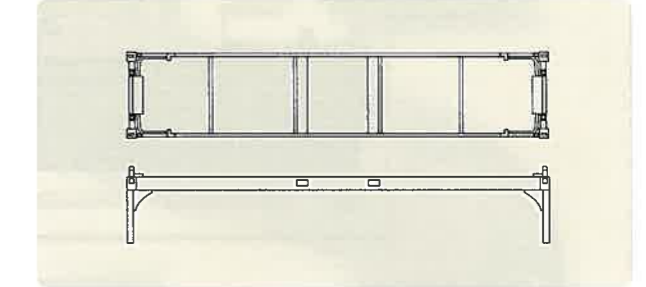

## LOCK TIGHT



Safety locking piece to stop turnbuckle screw reversion turn.

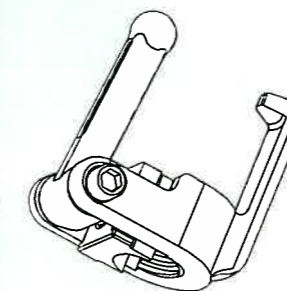

LOCK

OPEN

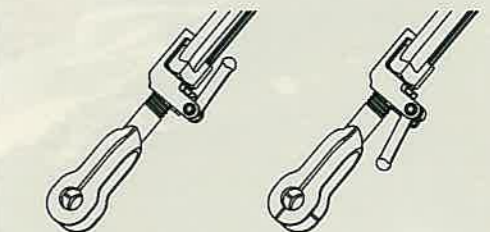

Weight: Abt. 1.0kg. Operation is only PUSH or PULL the lever.  
This locking piece is tightly to prevent turnbuckle shaft loose from sailing vibration.

## Container Stack calculating software AutoLASH **TATYO**

AutoLASH is a calculation software to check container stack weight by using container data from the ship's loading computer. To secure loaded freight container you can change lashing pattern or change weight position as trial. And it is possible to apply optimized lashing pattern automatically.

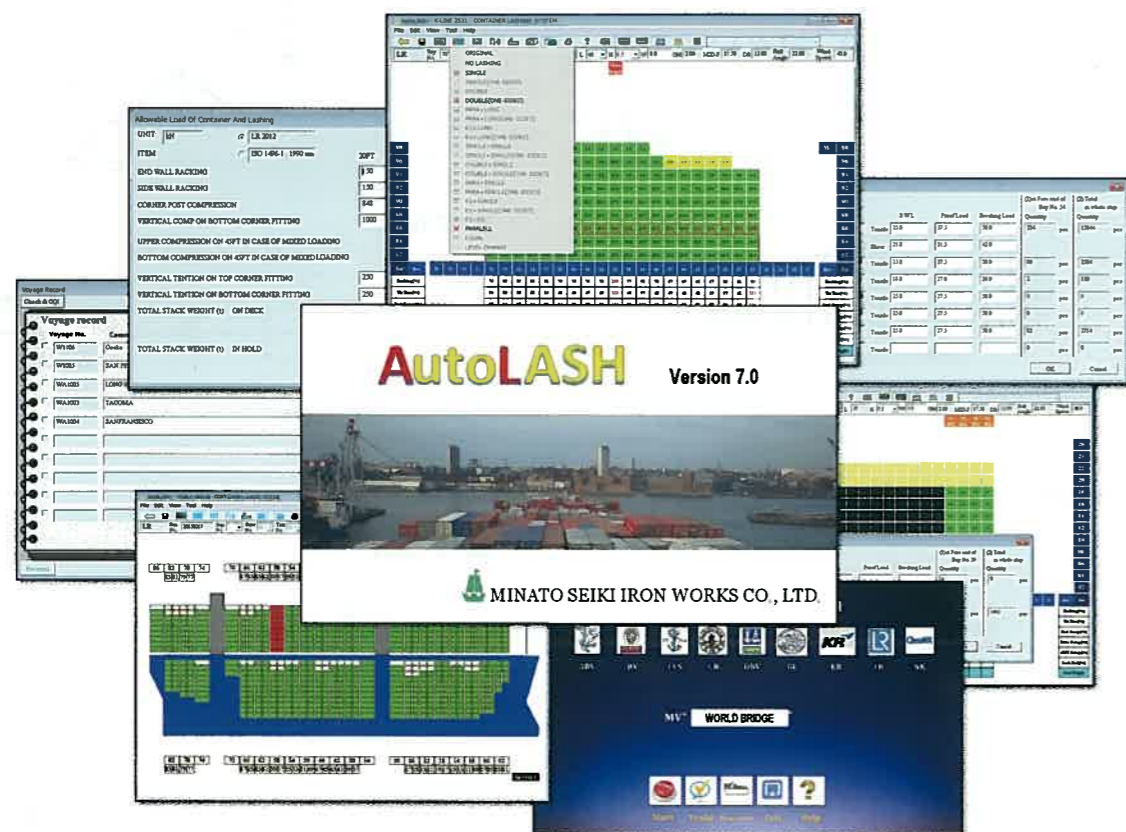

**MINATO SEIKI**

ashing



olution